

天线调谐，阻抗匹配的应用

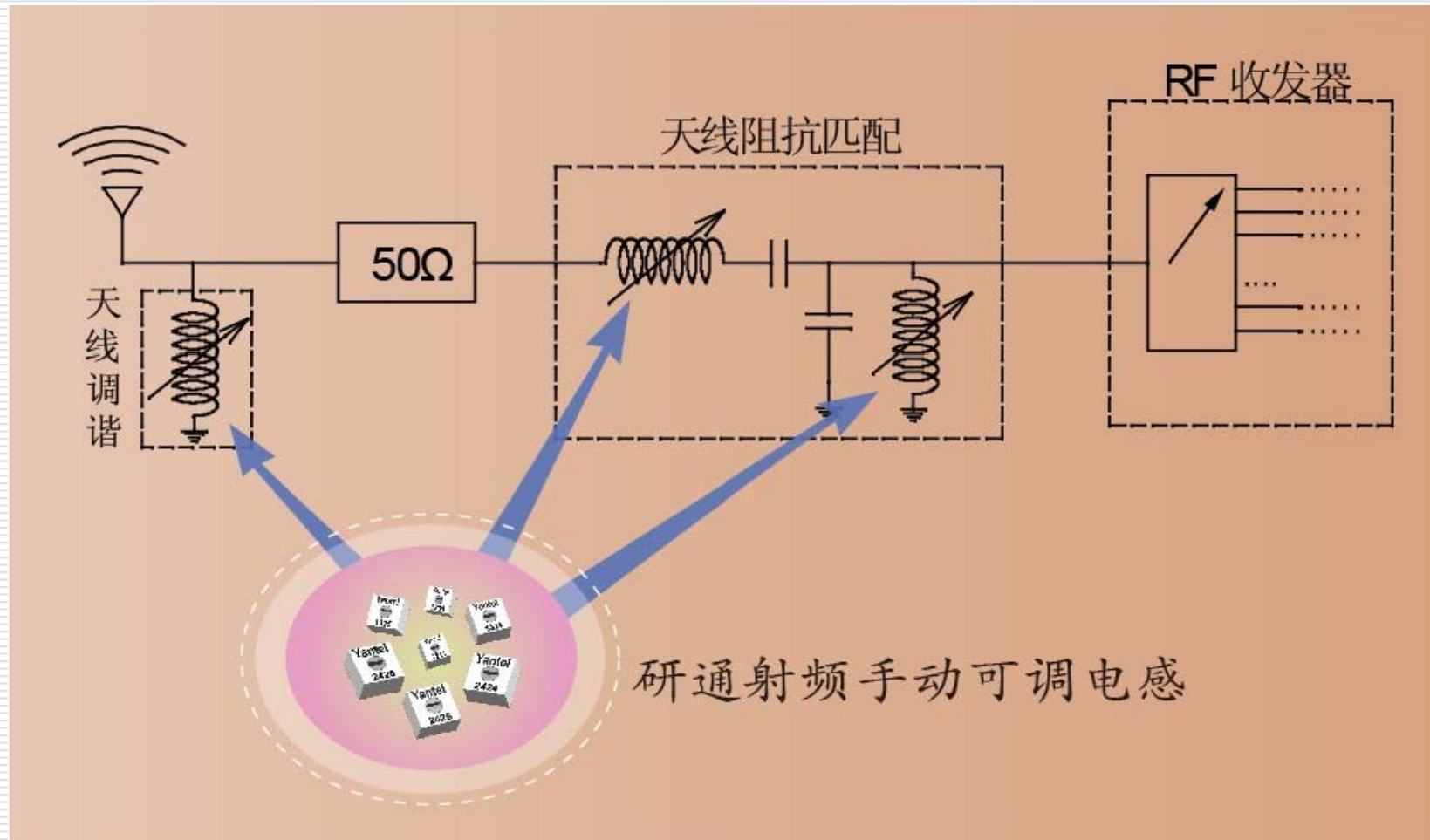

滤波器应用

● 点阻滤波器

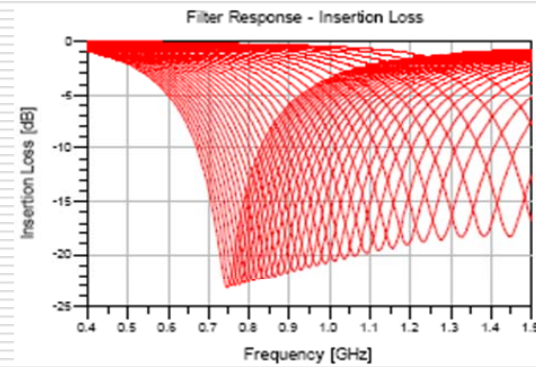
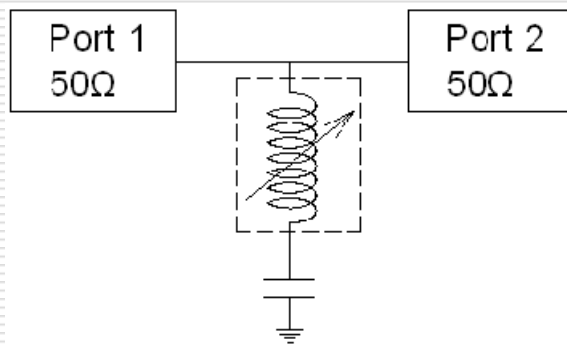

● 带通滤波器

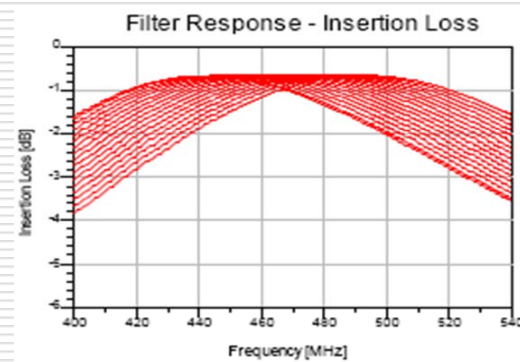
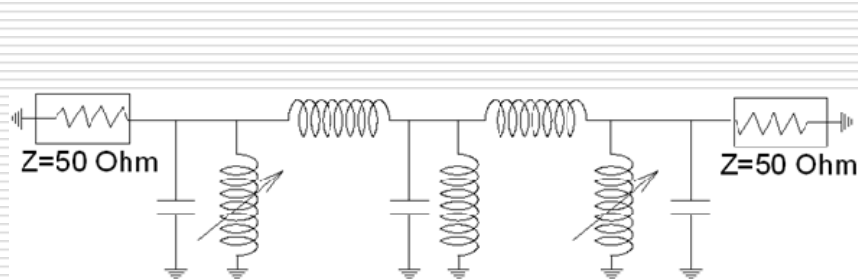

移相器应用

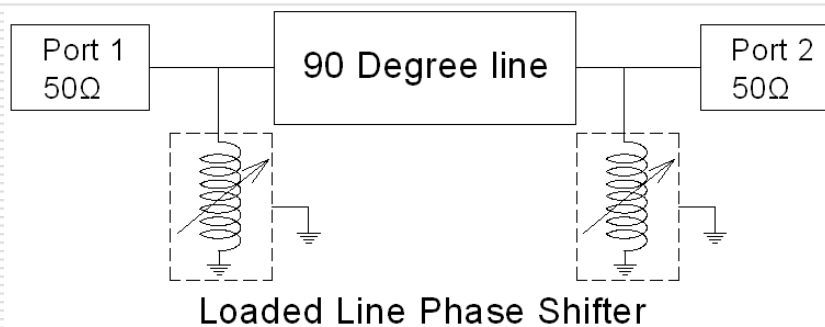
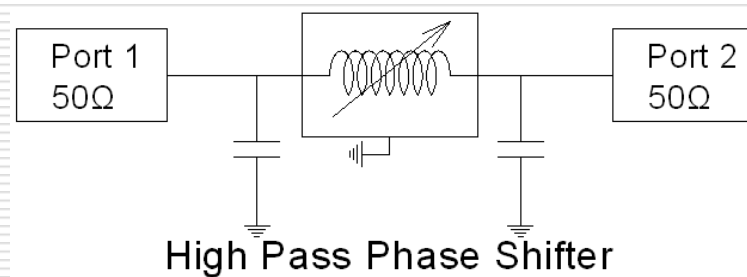
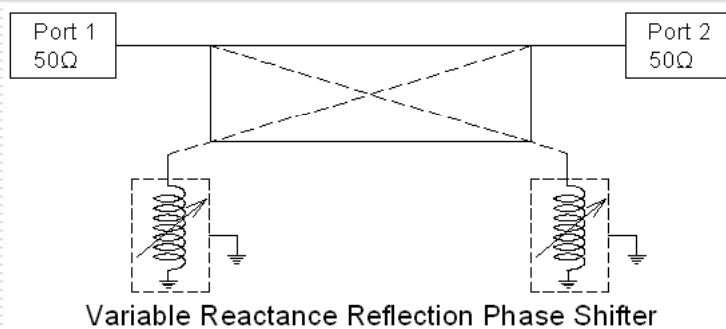

射频手动可调电感

应用

- ◆ 射频阻抗匹配
- ◆ 可调天线
- ◆ 可调振荡电路
- ◆ 可调滤波器
- ◆ 移相器
- ◆ 相控阵雷达
- ◆ 核磁共振 (NMR)
- ◆ 磁共振成像 (MRI)
- ◆ 宽带天线
- ◆ (耐高温) 汽车电子产品
(例汽车收音机倒车雷达)



天线



核磁共振



十路可调滤波器



汽车倒车雷达