

## KTCA 系列安装应用图：

- 频率: 16 to 36GHz
- 功率: 200mW
- 温度: -55℃ to 150℃
- 尺寸: 3.05\*1.65\*0.38mm
- 安装: 信号端 (金丝键合)  
背面接地端 (焊锡或导电硅胶)

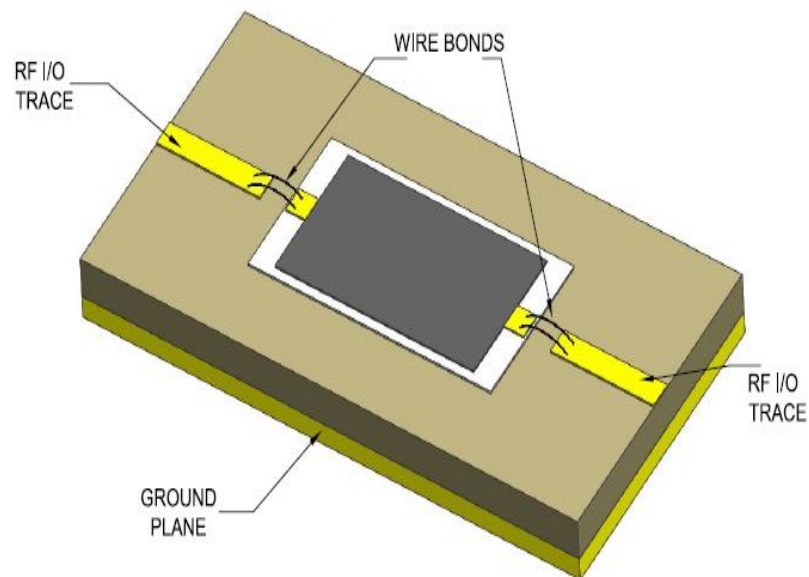
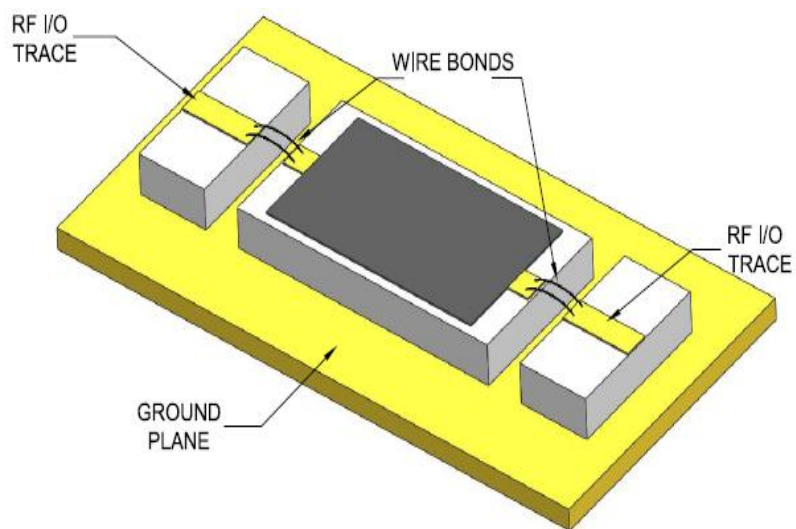
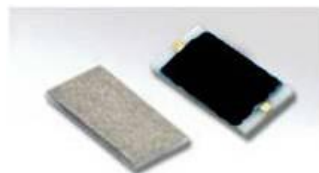

# WTCA(金电极)系列应用图:

- 频率: DC to 20GHz
- 功率: 200mW
- 温度: -55℃ to 150℃
- 尺寸: 1.52\*1.78\*0.38mm

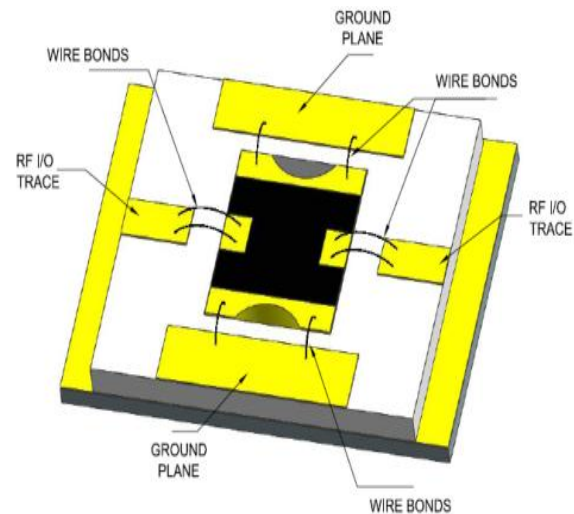
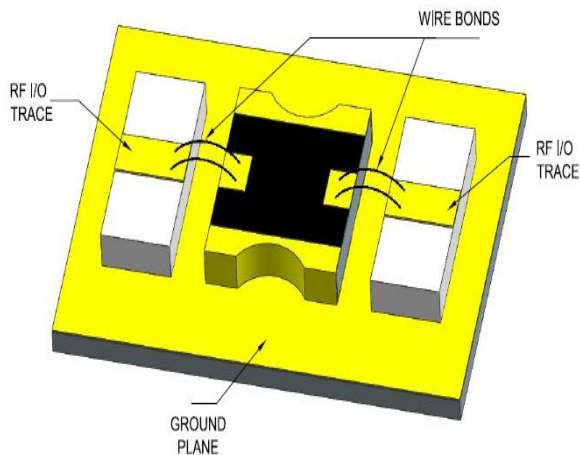
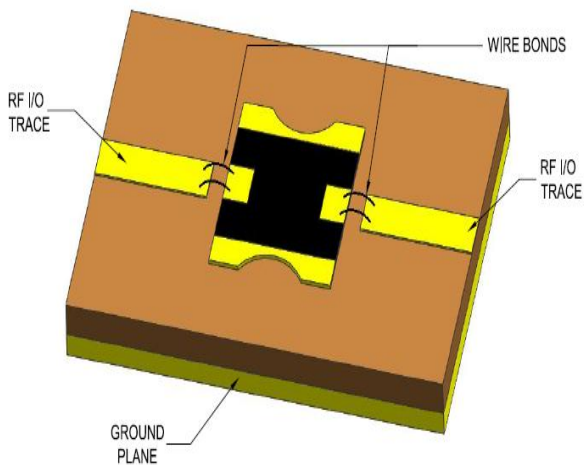
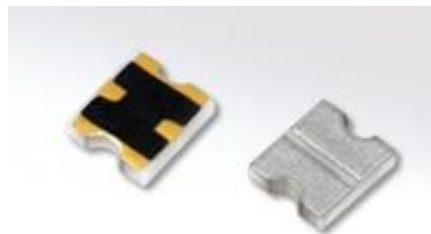

信号端: 金丝键合

接地端: 背面-焊锡或导电硅胶, 上面-金丝键合

## WTCA(锡电极)系列应用图:

- 频率: DC to 20GHz
- 功率: 200mW
- 温度: -55℃ to 150℃
- 尺寸: 1.52\*1.91\*0.38mm
- 安装: 信号端 (焊锡)  
接地端: 背面-焊锡或导电硅胶  
侧上面-焊锡

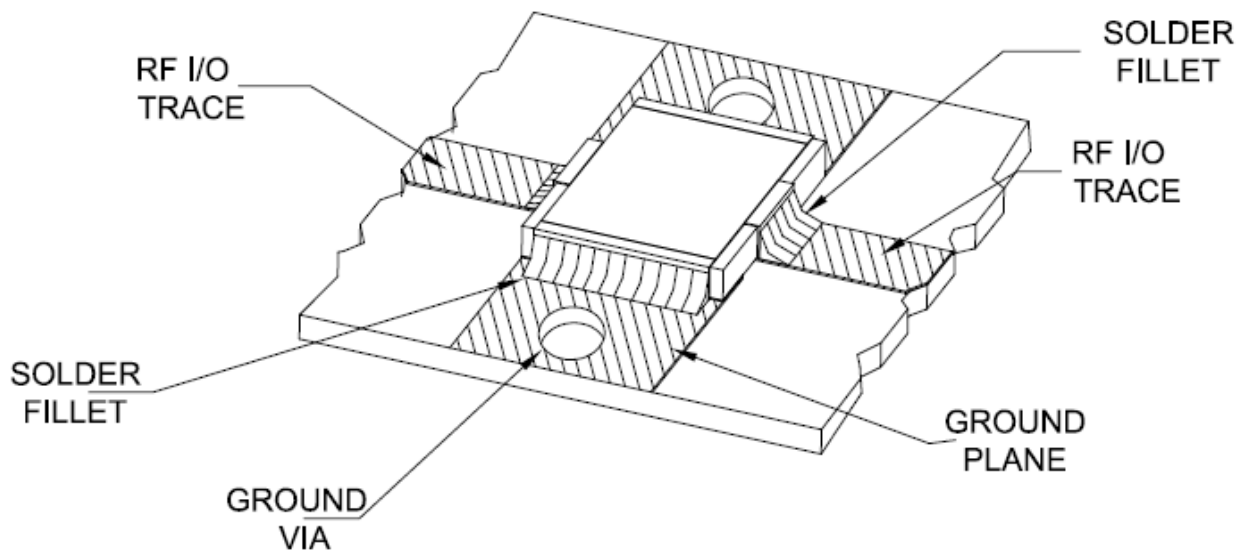
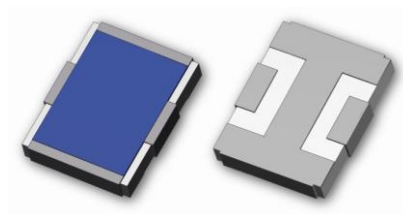

# HTCA(金电极-包地边)系列应用图:

- 频率: DC to 12.4GHz
- 功率: 200mW
- 温度: -55°C to 150°C
- 尺寸: 1.52\*1.91\*0.28mm

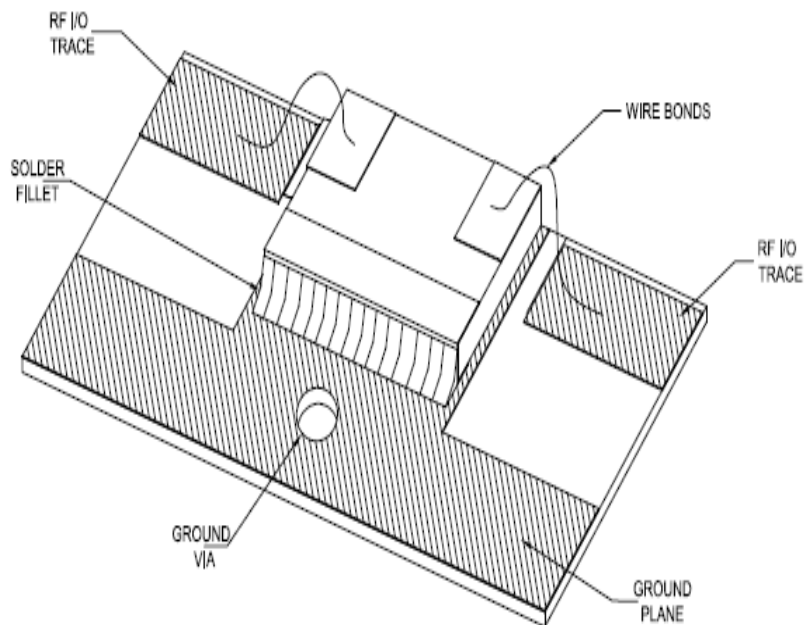
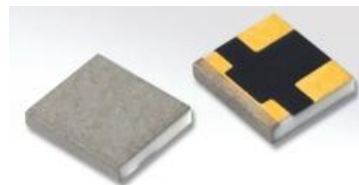

信号端: 金丝键合  
接地端: 背面-焊锡或导电硅胶+侧面-焊锡

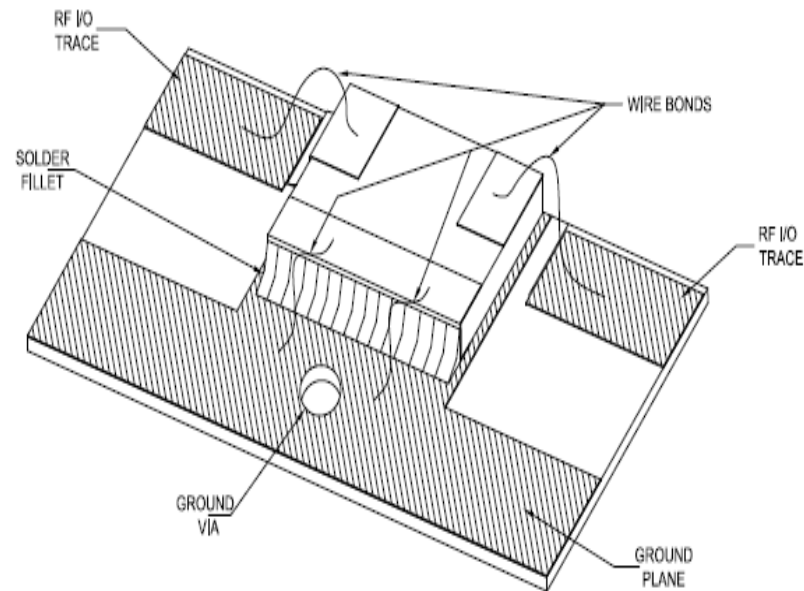

信号端: 金丝键合  
接地端: 侧面-焊锡+背面-导电硅胶或焊锡+上面-金丝键合

## HTCA(锡电极-包三边)系列应用图:

- 频率: DC to 12.4GHz
- 功率: 200mW
- 温度: -55°C to 150°C
- 尺寸: 1.52\*1.91\*0.28mm
- 安装: 电极 (焊锡)

