

# Data Sheet

## BD120U510-1306

### Ultra Low Profile 1306 Balun

### 50Ω to 100Ω Balanced



#### Features:

- 1000~1300 MHz
- 0.85mm Height Profile
- 50Ω to 2x50 Ω
- High CMRR
- Low Insertion Loss
- Input to Output DC Isolation
- Surface Mountable
- Tape & Reel
- Non-conductive Surface
- RoHS Compliant

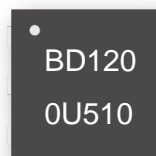
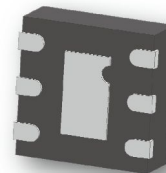

#### Applications

- WiMAX
- GPS
- UWB
- Bluetooth
- Zigbee
- GSM

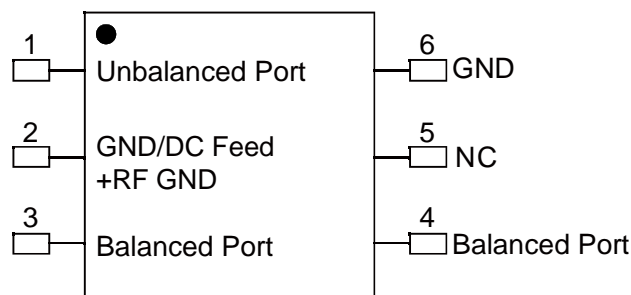

TOP VIEW

#### Electrical Specifications at 25° C

Parameter	Symbol	Min	Typ	Max	Unit
Frequency Range	F	1000		1300	MHz
Unbalanced Port Impedance			50		Ω
Balanced Port Impedance			100		Ω
Return Loss	RL		10		dB
Insertion Loss	IL		1	1.3	dB
Amplitude balance	Abal		0.3		dB
Phase balance	Φ bal		2	4	deg
CMRR			32		dB

#### Yantel Corporation

Add: 3F, Building 3, Southern District 2 of Zhongguan Honghualing Industrial Park, Xili, Nanshan, Shenzhen, China

Tel: 86-755-8355-1886 Fax: 86-755-8355-2533

Rev A1

For detailed performance specs & shopping online see Yantel web site : [www.yantel-corp.com](http://www.yantel-corp.com)

# Data Sheet

## BD1200U510-1306

### Ultra Low Profile 1306 Balun

### 50Ω to 100Ω Balanced



#### Typical Performance (25°C: 1000-1400 MHz)

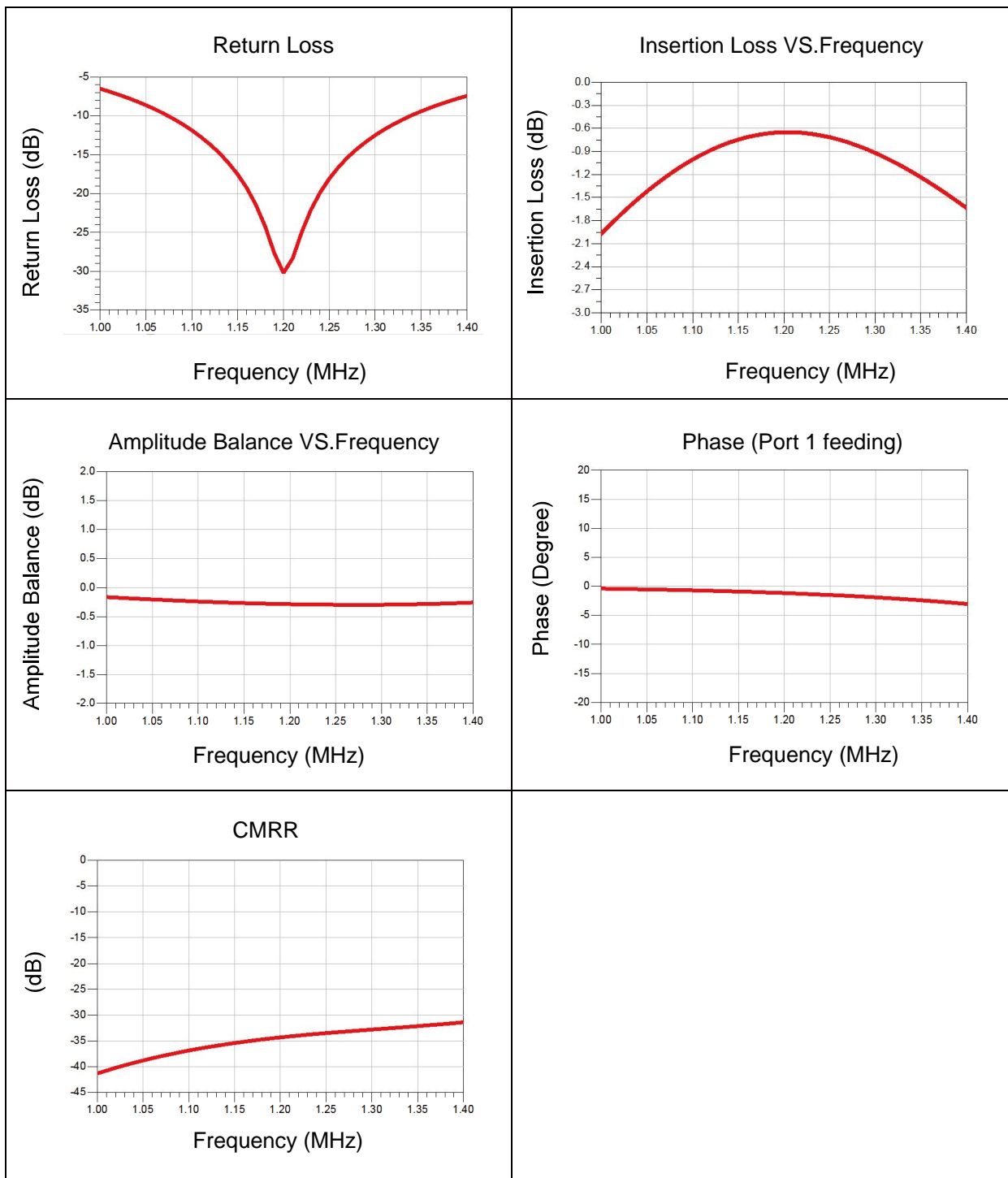

#### Yantel Corporation

Add: 3F, Building 3, Southern District 2 of Zhongguan Honghualing Industrial Park, Xili, Nanshan, Shenzhen, China  
 Tel: 86-755-8355-1886 Fax: 86-755-8355-2533

Rev A1

For detailed performance specs & shopping online see Yantel web site : [www.yantel-corp.com](http://www.yantel-corp.com)

# Data Sheet

## BD120U510-1306

### Ultra Low Profile 1306 Balun

### 50Ω to 100Ω Balanced



## Outline Drawing

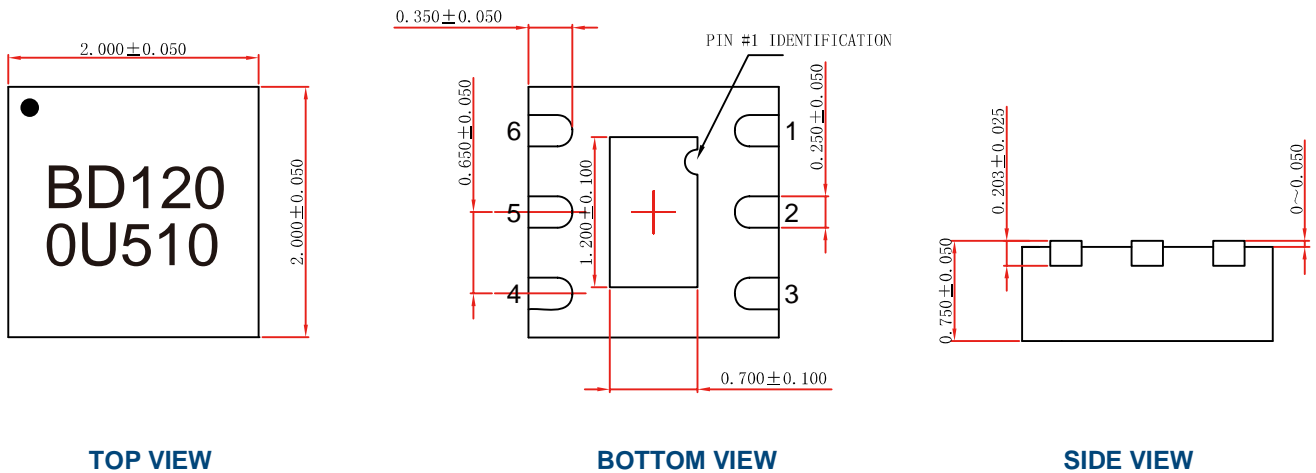

TOP VIEW

BOTTOM VIEW

SIDE VIEW

## Land Pattern

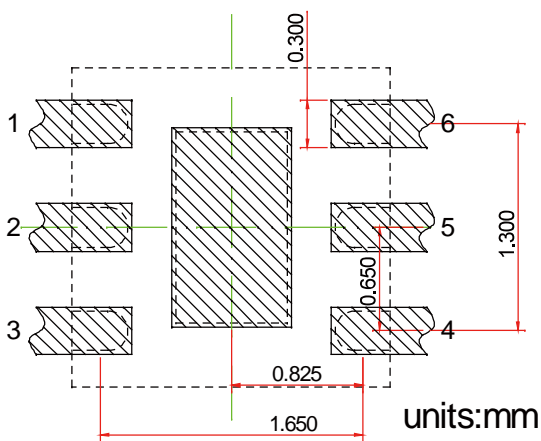

## Recommended Land Pattern Top View

Notes: All dimensions show in millimeters

## Pin Out

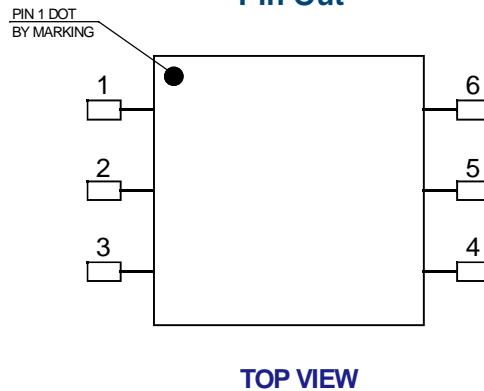

Pin #	Connection
1	Unbalanced Port
2	GND/DC Feed+RF GND
3	Balanced Port
4	Balanced Port
5	NC
6	GND

## Yantel Corporation

Add: 3F, Building 3, Southern District 2 of Zhongguan Honghualing Industrial Park, Xili, Nanshan, Shenzhen, China  
Tel: 86-755-8355-1886 Fax: 86-755-8355-2533

Rev A1

For detailed performance specs & shopping online see Yantel web site : [www.yantel-corp.com](http://www.yantel-corp.com)