

Description

The DC1500W36 is a low profile, high performance 36dB directional coupler. It is designed for DCS & PCS applications. This component is suitable for feed-forward amplifier and signal sampling circuits where low insertion loss, high directivity is required. It can be used in power applications up to 200 Watts.

Parts have been subjected to rigorous qualification testing and they are using materials with coefficients for thermal expansion (CTE) compatible with common substrates such as FR4, G-10, RF-35, RO4350B and polyimide.

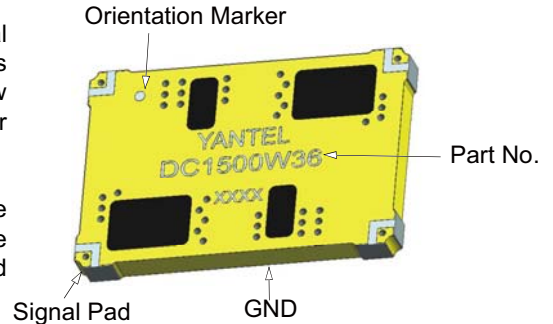

Features:

- 500-2700 MHz
- DCS & PCS
- Low Insertion Loss
- High Directivity
- Low VSWR
- Good Repeatability
- CTE compatible with FR4, G-10, RF-35, RO4350B and polyimide
- Immersion gold, prevent surface oxidation & scratch
- RoHS Compliant
- Tape & Reel Package available

Electrical Specifications (typical)

Frequency MHz	Forward Coupled dB	Directivity dB Min	Return Loss dB Min
500-2700	36±1.5	18	18
Insertion Loss dB Max	Power Avg. CW Watts	Operating Temp. °C	
0.4	200	-55 to +85	

Note:

1. All above test data resulting from specify demo board.
2. Insertion loss has removed the thru board loss.

Mechanical Outline

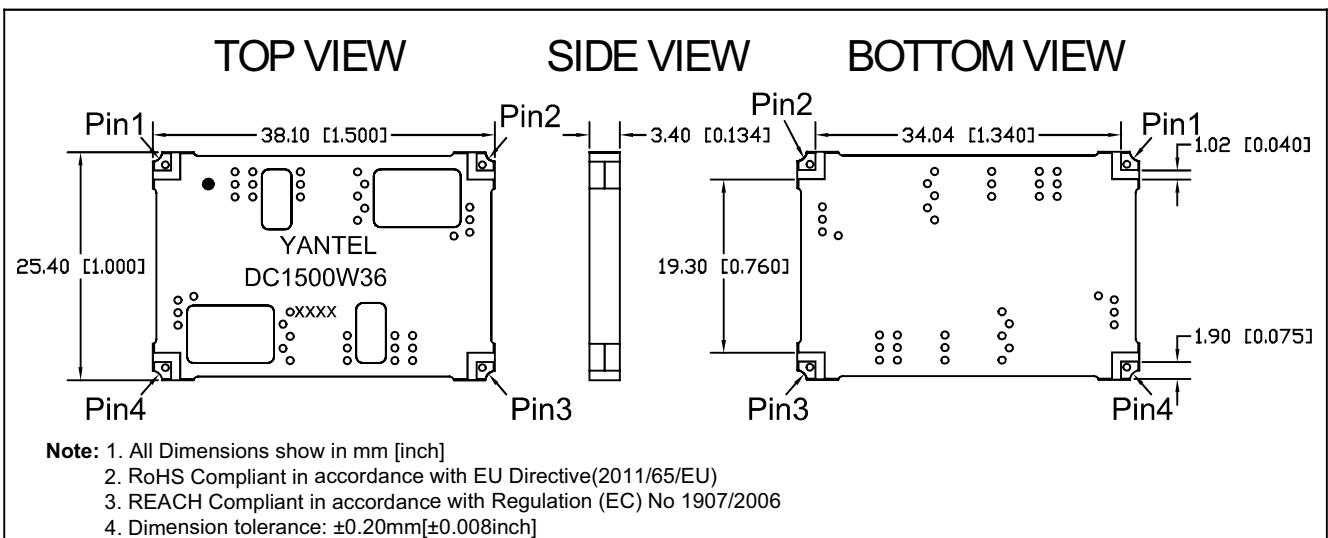

Yantel Corporation

Add: 3F, Building 3, Southern District 2 of Zhongguan Honghualing Industrial Park, Xili, Nanshan, Shenzhen, China
 Tel: 86-755-8355-1886 Fax: 86-755-8355-2533
 For detailed performance specs & shopping online see Yantel web site : www.yantel-corp.com

Directional Coupler Pin Configuration

The DC1500W36 has an orientation marker to denote Pin1. Once port one has been identified the other ports are known automatically. Please see the chart below for clarification:

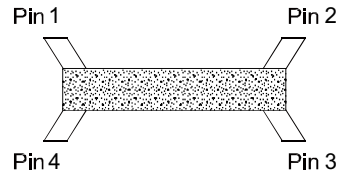

Pin 1	Pin 2	Pin 3	Pin 4
Input	Reflected Coupled	Transmission	Forward Coupled
Transmission	Forward Coupled	Input	Reflected Coupled

Typical Performance Data (@25°C)

Frequency (MHz)	Forward Coupled (dB)	Transmission (dB)	Insertion Loss (dB)	Reflected Coupled (dB)	Return Loss(dB)	
					S11	S33
500	-36.17	-0.02	-0.01	-57.53	-21.66	-22.23
610	-35.73	-0.01	-0.01	-56.53	-21.63	-22.02
720	-35.44	-0.03	-0.03	-55.71	-22.57	-23.61
830	-35.29	-0.03	-0.03	-54.94	-24.63	-25.76
940	-35.25	-0.04	-0.04	-54.71	-28.75	-32.04
1050	-35.32	-0.04	-0.04	-54.45	-39.20	-52.43
1160	-35.45	-0.08	-0.08	-54.50	-35.42	-30.49
1270	-35.64	-0.06	-0.06	-54.62	-27.32	-24.54
1380	-35.96	-0.14	-0.14	-55.35	-23.76	-22.43
1490	-36.23	-0.12	-0.12	-56.03	-21.72	-20.27
1600	-36.53	-0.13	-0.13	-56.77	-20.88	-20.51
1710	-36.72	-0.18	-0.18	-57.50	-20.76	-20.13
1820	-36.76	-0.06	-0.06	-58.99	-21.64	-22.43
1930	-36.81	-0.15	-0.15	-59.91	-23.55	-24.42
2040	-36.46	-0.09	-0.04	-61.06	-27.53	-31.60
2150	-36.28	-0.14	-0.03	-60.59	-35.78	-35.83
2260	-35.81	-0.13	-0.04	-61.86	-33.00	-27.00
2370	-35.46	-0.20	-0.06	-62.81	-25.56	-21.77
2480	-35.21	-0.19	-0.19	-63.17	-21.93	-20.09
2590	-35.27	-0.27	-0.27	-63.15	-19.80	-17.91
2700	-35.42	-0.04	-0.04	-63.70	-18.85	-18.39

Yantel Corporation

Add: 3F, Building 3, Southern District 2 of Zhongguan Honghualing Industrial Park, Xili, Nanshan, Shenzhen, China
 Tel: 86-755-8355-1886 Fax: 86-755-8355-2533
 For detailed performance specs & shopping online see Yantel web site : www.yantel-corp.com

Typical Performance (-55°C, 25°C, 95°C, 125°C : 500-2700 MHz)

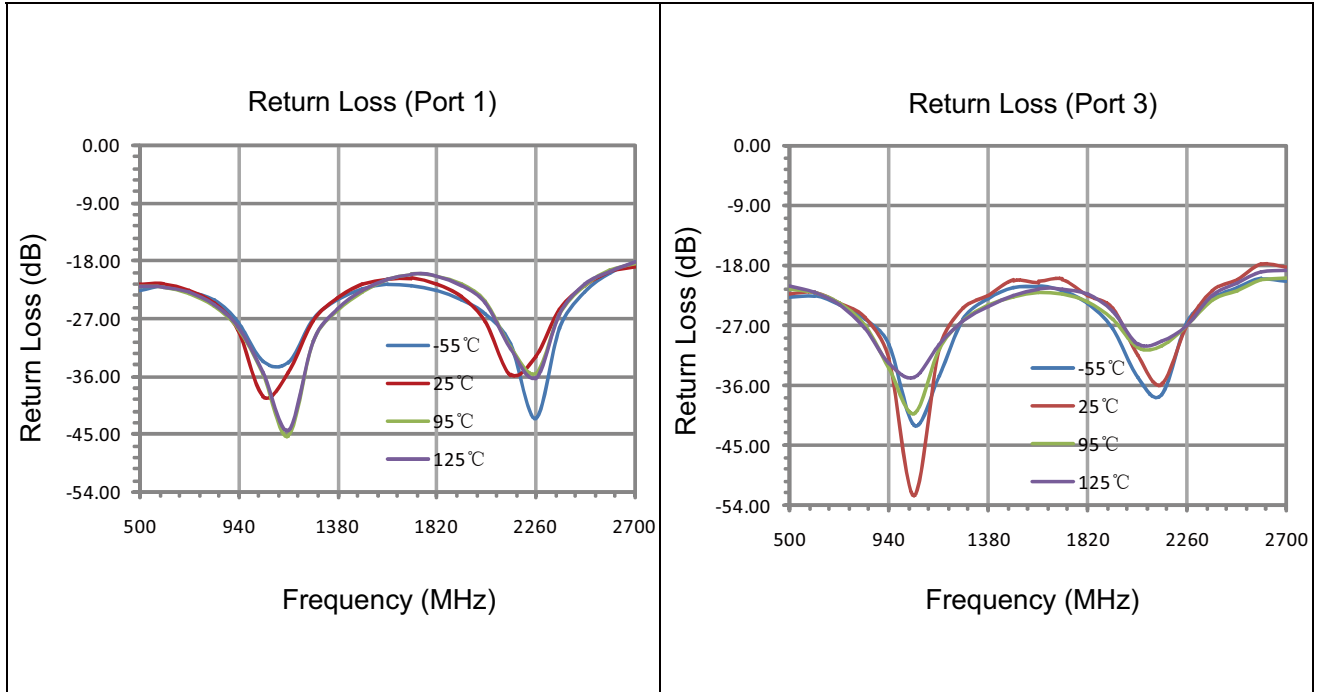

Yantel Corporation

Add: 3F, Building 3, Southern District 2 of Zhongguan Honghualing Industrial Park, Xili, Nanshan, Shenzhen, China
 Tel: 86-755-8355-1886 Fax: 86-755-8355-2533
 For detailed performance specs & shopping online see Yantel web site : www.yantel-corp.com

Typical Performance (-55°C, 25°C, 95°C, 125°C : 500-2700 MHz)

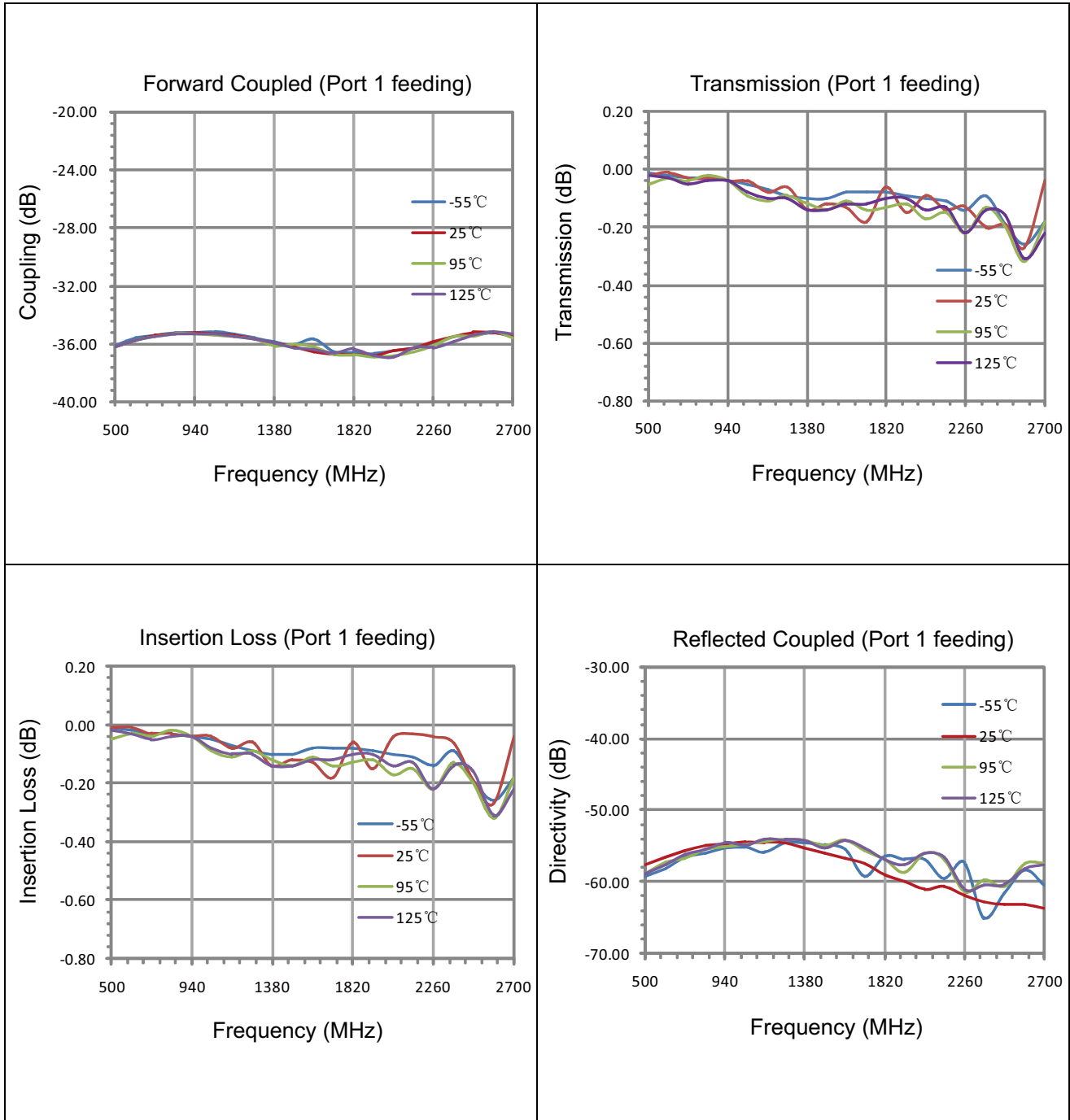

Yantel Corporation

Add: 3F, Building 3, Southern District 2 of Zhongguan Honghualing Industrial Park, Xili, Nanshan, Shenzhen, China
 Tel: 86-755-8355-1886 Fax: 86-755-8355-2533
 For detailed performance specs & shopping online see Yantel web site : www.yantel-corp.com

Description of Measured Specifications

Parameter	Description
VSWR	Voltage standing wave ratio, the impedance match to 50Ω , the ideal value is 1:1.
Return Loss	Loss of signal power resulting from the reflection caused by discontinuity of transmission line.
Insertion Loss	The input power divided by sum of power at the Forward Coupled port & transmission port
Forward Coupled	The input power divided by the power at coupling port.
Transmission	The input power divided by the power at transmission port.
Directivity	The power at the Forward Coupled port divided by the power at the Reflected Coupled port

Test Method

1. Calibrating your vector network analyzer.
2. Connect the VNA 4 Port to DUT respectively.
3. Measure the data of Forward coupled through port 1 to port 4(S41).
4. Measure the data of transmission through port 1 to port 3(S31).
5. Measure the data of Reflected Coupled through port 1 to port 2(S21).
6. Measure the data of return loss port 1, port 3.
7. According to the above data to calculate insertion loss, directivity.

Note:

1. When calculating insertion loss at room temperature, coupling & transmission data both need remove demo board loss. Please see demo board loss data below the table :

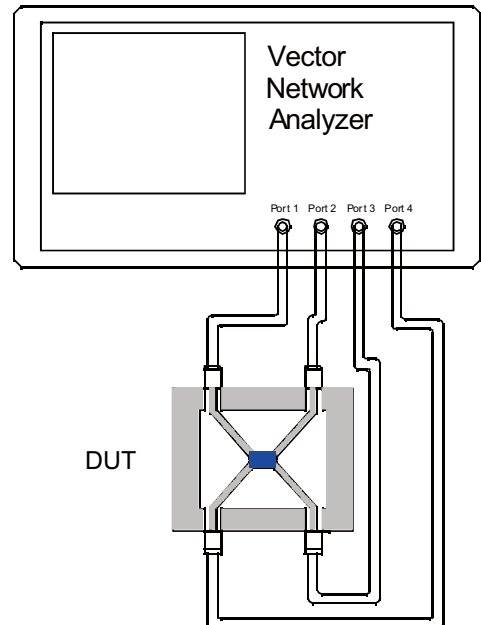

Yantel Corporation

Recommended PCB Layout

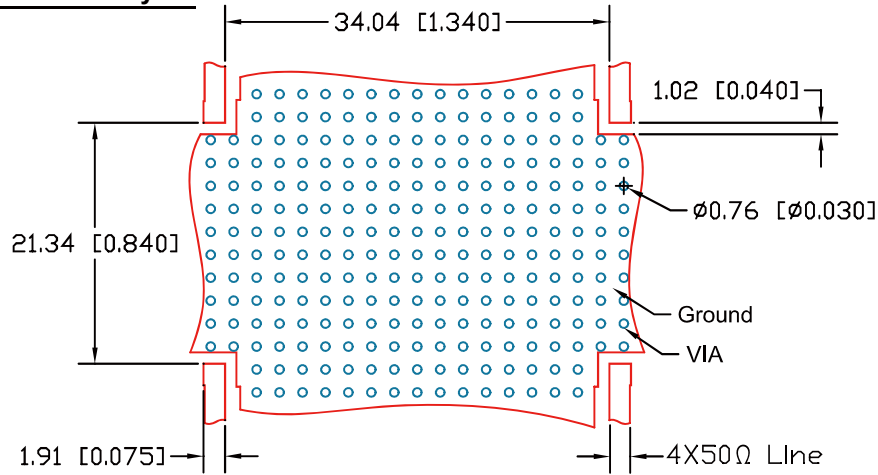

NOTE:

- 50 Ω line width is shown above designing from RO4003 dielectric thickness 0.81mm; copper 1 OZ
- Bottom side of the PCB is continuous ground plane.
- All dimensions shown in mm [inch].

Reflow Profile

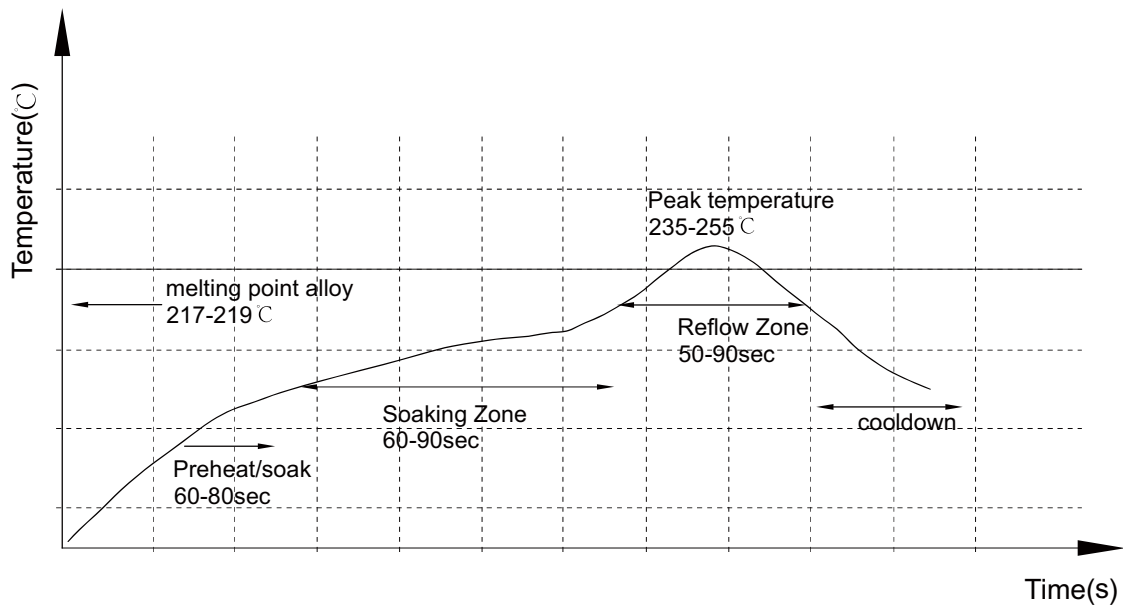

Yantel Corporation

Add: 3F, Building 3, Southern District 2 of Zhongguan Honghualing Industrial Park, Xili, Nanshan, Shenzhen, China
 Tel: 86-755-8355-1886 Fax: 86-755-8355-2533
 For detailed performance specs & shopping online see Yantel web site : www.yantel-corp.com

Reliability Test Flow

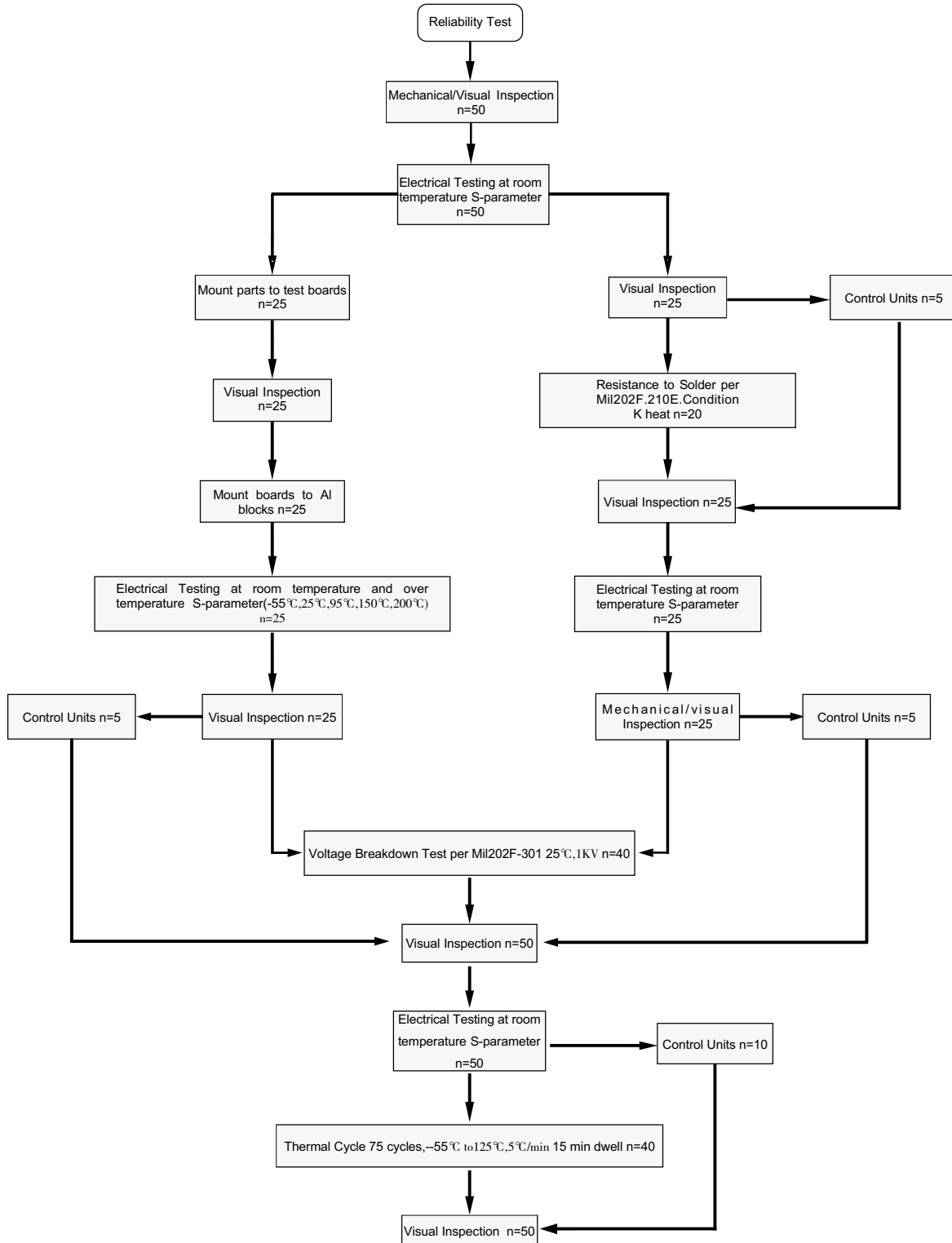

Yantel Corporation

Add: 3F, Building 3, Southern District 2 of Zhongguan Honghualing Industrial Park, Xili, Nanshan, Shenzhen, China
 Tel: 86-755-8355-1886 Fax: 86-755-8355-2533
 For detailed performance specs & shopping online see Yantel web site : www.yantel-corp.com

Reliability Test Flow



Yantel Corporation