

Description

The HC1400G03 is a low profile, high performance 3dB hybrid coupler in a new easy to use, manufacturing friendly surface mount package. It is designed for DCS & PCS band applications. The HC1400G03 is particularly for balanced power and low noise amplifiers, plus signal designed distribution and other applications where low insertion loss and tight amplitude and phase balance is required. It can be used in high power applications up to 400 Watts.

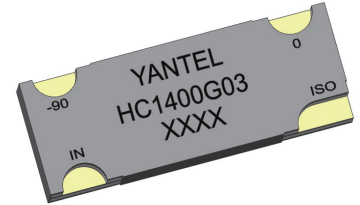

Features:

- 1100-1700 MHz
- High Power
- Very Low Loss
- Tight Amplitude Balance
- High Isolation
- Low VSWR
- Good Repeatability
- RoHS Compliant
- Tape & Reel Package available

Electrical Specifications

Frequency	Isolation	Insertion Loss	Return loss
<i>MHz</i>	<i>dB Min</i>	<i>dB Max</i>	<i>dB Min</i>
1100 - 1700	19	0.30	18
Amplitude Balance	Phase Balance	Power	Operating Temp.
<i>dB Max</i>	<i>Degrees</i>	<i>Avg. CW Watts</i>	<i>°C</i>
± 0.40	90 ± 3.0	400	-55 to +85

Notes:

1. All the above data are based on specified demo board.
2. Insertion loss: Thru board loss has been removed.

Mechanical Outline

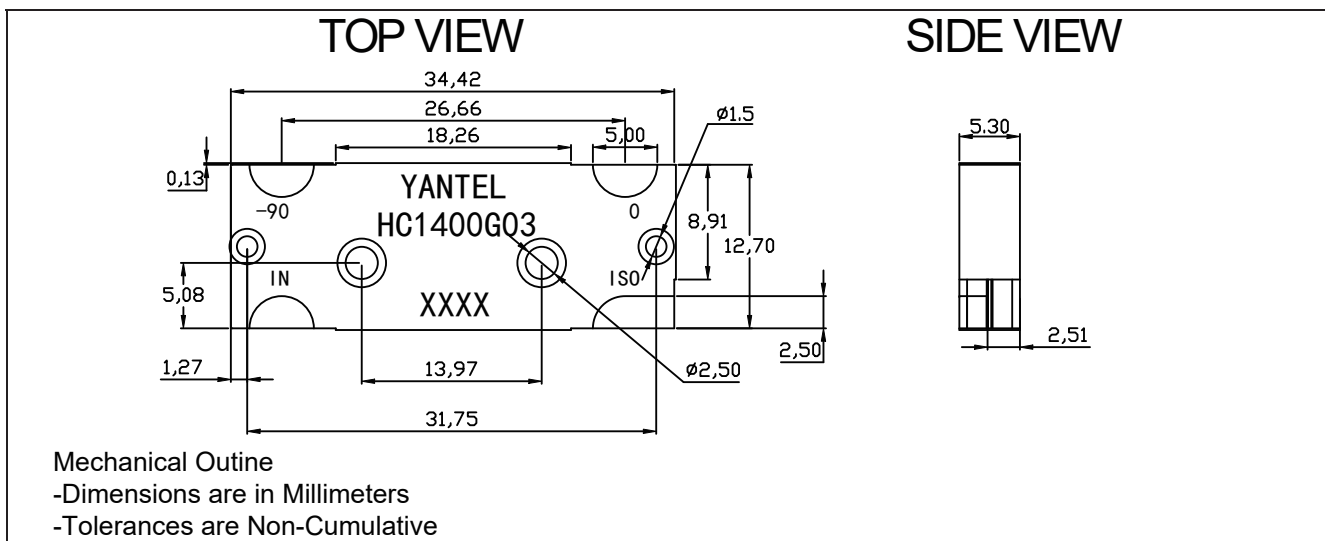

Yantel Corporation

Add: No.308-322, 3F, Building 1, Juchuang Jingu Innovation Park, Wenyuan Road 35, Xili Street, Nanshan, Shenzhen, China
 Tel: 86-755-8355-1886 Fax: 86-755-8355-2533

For detailed performance specs & shopping online see Yantel web site : www.yantel-corp.com

Hybrid Coupler Pin Configuration

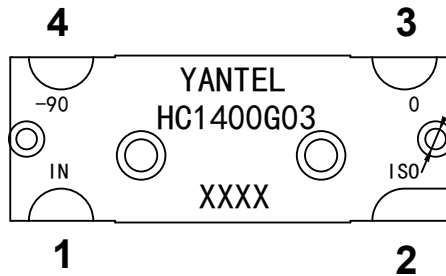

PORT CONFIGURATION				
INPUT	1	2	3	4
1	---	ISOLATION	-3dB<0 DEG	-3dB<-90 DEG
2	ISOLATION	---	-3dB<-90 DEG	-3dB<0 DEG
3	-3dB<0 DEG	-3dB<-90 DEG	---	ISOLATION
4	-3dB<-90 DEG	-3dB<0 DEG	ISOLATION	---

Typical Performance Data (@25)

Frequency (MHz)	Coupling (dB)	Transmission (dB)	Insertion Loss (dB)	Isolation (dB)	Amplitude Balance (dB)	Phase (degree)	Return Loss(dB)			
							S11	S22	S33	S44
1100	-3.26	-2.93	-0.08	-23.59	-0.16	-89.48	-23.83	-26.34	-22.81	-24.15
1130	-3.21	-2.98	-0.09	-23.62	-0.12	-89.47	-23.57	-26.51	-22.37	-23.79
1160	-3.17	-3.03	-0.09	-23.62	-0.07	-89.44	-23.33	-26.70	-21.93	-24.01
1190	-3.13	-3.06	-0.08	-23.51	-0.04	-89.45	-23.38	-26.22	-22.02	-23.84
1220	-3.10	-3.09	-0.09	-23.29	0.00	-89.46	-23.32	-26.10	-21.91	-23.50
1250	-3.08	-3.12	-0.09	-23.32	0.02	-89.45	-23.11	-26.47	-21.41	-23.64
1280	-3.05	-3.15	-0.09	-23.27	0.05	-89.46	-23.05	-26.04	-21.39	-23.75
1310	-3.04	-3.17	-0.09	-23.06	0.06	-89.48	-22.95	-25.80	-21.63	-23.22
1340	-3.04	-3.19	-0.10	-22.96	0.07	-89.47	-22.54	-26.05	-21.18	-23.02
1370	-3.02	-3.18	-0.09	-23.07	0.08	-89.49	-22.28	-26.26	-20.88	-23.23
1400	-3.02	-3.19	-0.09	-22.96	0.09	-89.43	-22.26	-25.64	-21.15	-23.11
1430	-3.03	-3.19	-0.10	-22.73	0.08	-89.41	-22.08	-25.54	-20.95	-22.67
1460	-3.04	-3.18	-0.10	-22.78	0.07	-89.48	-21.89	-25.84	-20.52	-22.82
1490	-3.04	-3.17	-0.10	-22.70	0.06	-89.47	-21.79	-25.45	-20.66	-23.00
1520	-3.07	-3.16	-0.10	-22.50	0.04	-89.41	-21.84	-25.36	-20.78	-22.58
1550	-3.09	-3.13	-0.10	-22.43	0.02	-89.47	-21.53	-25.60	-20.27	-22.60
1580	-3.12	-3.11	-0.10	-22.42	-0.01	-89.41	-21.40	-25.53	-20.15	-22.65
1610	-3.16	-3.08	-0.11	-22.21	-0.04	-89.39	-21.46	-24.95	-20.37	-22.42
1640	-3.20	-3.05	-0.11	-22.07	-0.08	-89.36	-21.21	-25.19	-19.97	-22.42
1670	-3.25	-3.00	-0.11	-21.97	-0.13	-89.39	-21.07	-25.38	-19.63	-22.61
1700	-3.30	-2.96	-0.12	-21.96	-0.18	-89.37	-21.11	-24.96	-20.02	-22.40

Yantel Corporation

Add: No.308-322, 3F, Building 1, Juchuang Jingu Innovation Park, Wenyuan Road 35, Xili Street, Nanshan, Shenzhen, China

Tel: 86-755-8355-1886 Fax: 86-755-8355-2533

 For detailed performance specs & shopping online see Yantel web site : www.yantel-corp.com

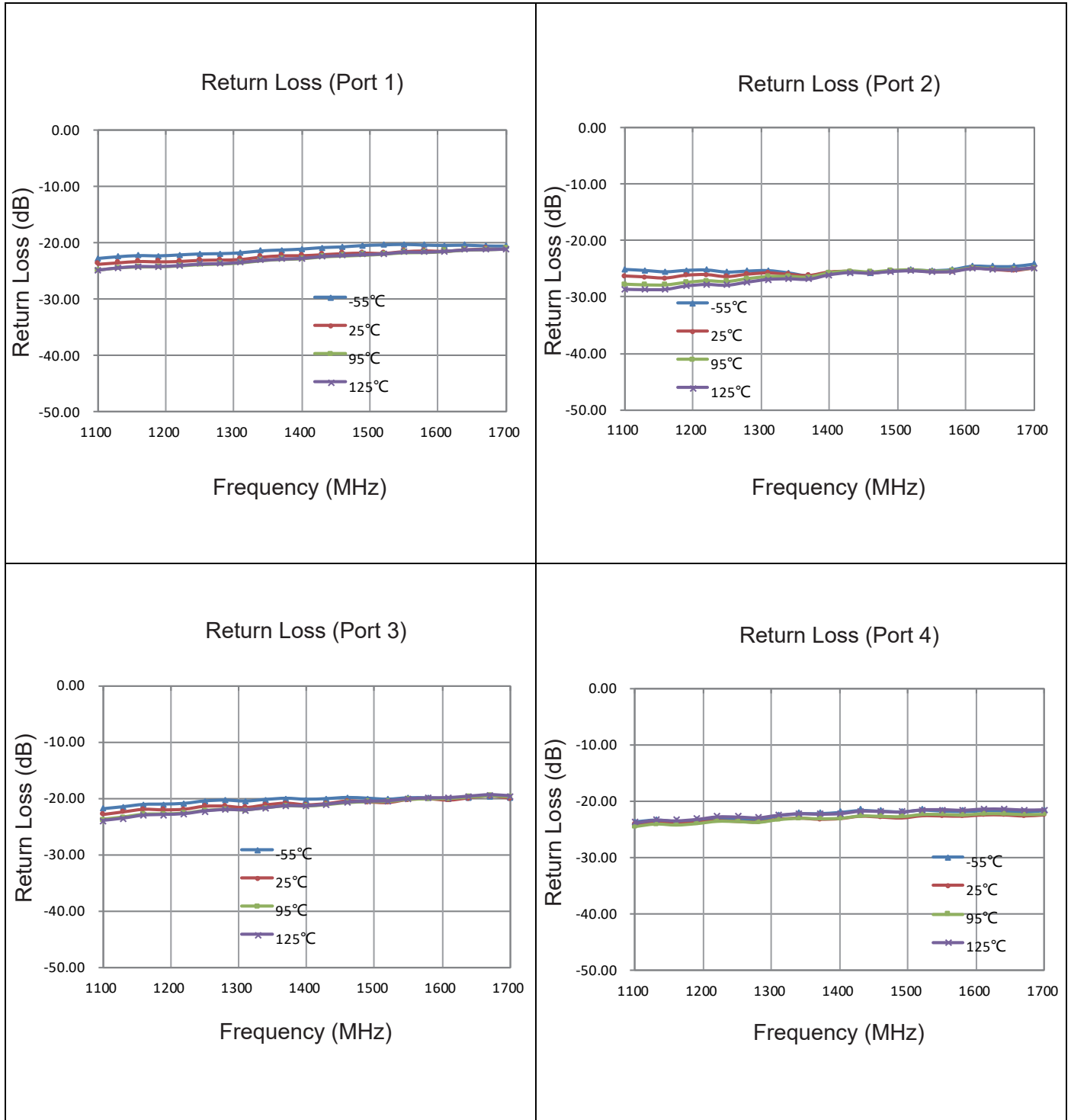
Typical Performance (-55°C, 25°C, 95°C, 125°C: 1100-1700MHz)

Yantel Corporation

 Add: No.308-322, 3F, Building 1, Juchuang Jingu Innovation Park, Wenyuan Road 35, Xili Street, Nanshan, Shenzhen China
 Tel: 86-755-8355-1886 Fax: 86-755-8355-2533

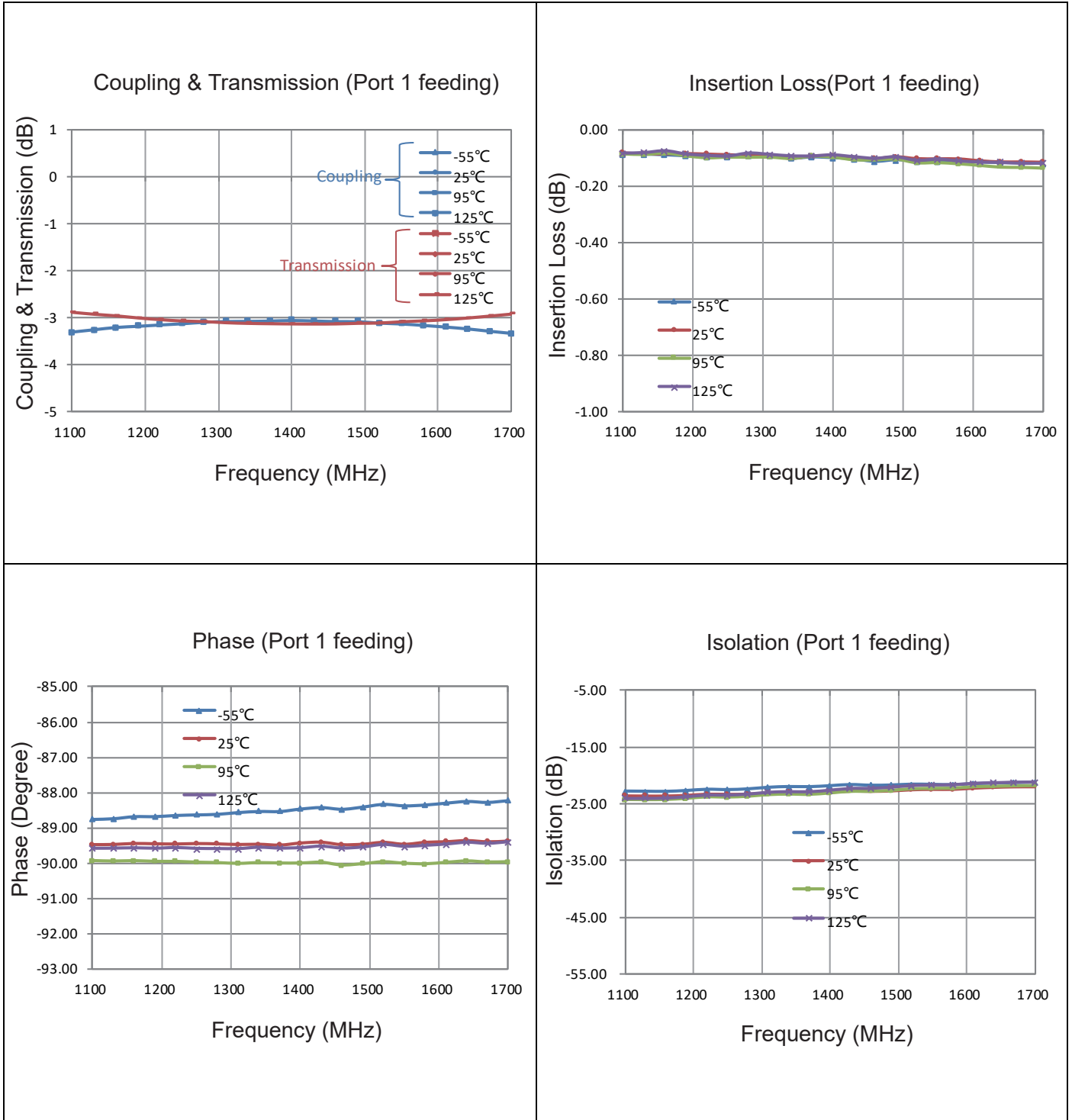
 For detailed performance specs & shopping online see Yantel web site : www.yantel-corp.com

Typical Performance (-55°C, 25°C, 95°C, 125°C: 1100-1700 MHz)

Yantel Corporation

 Add: No.308-322, 3F, Building 1, Juchuang Jingu Innovation Park, Wenyuan Road 35, Xili Street, Nanshan, Shenzhen China
 Tel: 86-755-8355-1886 Fax: 86-755-8355-2533

 For detailed performance specs & shopping online see Yantel web site : www.yantel-corp.com

Definition of Measured Specifications

Parameter	Definition	Mathematical Representation
VSWR (Voltage Standing Wave Ratio)	The impedance match of the coupler to a 50Ω system. A VSWR of 1:1 is optimal.	$VSWR = \frac{V_{max}}{V_{min}}$ Vmax = voltage maxima of a standing wave Vmin = voltage minima of a standing wave
Return Loss	The impedance match of the coupler to a 50Ω system. Return Loss is an alternate means to express VSWR.	$\text{Return Loss (dB)} = 20 \log \frac{VSWR + 1}{VSWR - 1}$
Insertion Loss	The input power divided by the sum of the power at the two output ports.	$\text{Insertion Loss(dB)} = 10 \log \frac{P_{in}}{P_{cpl} + P_{transmission}}$
Isolation	The input power divided by the power at the isolated port.	$\text{Isolation(dB)} = 10 \log \frac{P_{in}}{P_{iso}}$
Phase Balance	The difference in phase angle between the two output ports.	Phase at coupled port – Phase at transmission port
Amplitude Balance	The power at each output divided by the average power of the two outputs.	$10 \log \frac{P_{cpl}}{\left(\frac{P_{cpl} + P_{transmission}}{2}\right)} \quad \text{or} \quad 10 \log \frac{P_{transmission}}{\left(\frac{P_{cpl} + P_{transmission}}{2}\right)}$

Test Method

1. Calibrating your vector network analyzer.
2. Connect the VNA 4 Port to DUT respectively.
3. Measure the data of coupling through port 1 to port 4(S41).
4. Measure the data of transmission through port 1 to port 3(S31).
5. Measure the data of isolation through port 1 to port 2(S21).
6. Measure the data of phase port 4 & port 3(port 1 feeding).
7. Measure the data of return loss port 1, port 2, port 3 & port 4.
8. According to the above data to calculate insertion loss, amplitude balance & phase.

Note:

1. When calculating insertion loss at room temperature, demo board loss should be removed from both coupling & transmission data. Please refer to the below table for demo board loss :

Frequency Range(MHz)	Demo Board Loss (dB) @25°C
470-860	0.07
800-1000	0.10
1200-1700	0.15
1700-2000	0.15
2000-2300	0.20
2300-2700	0.25

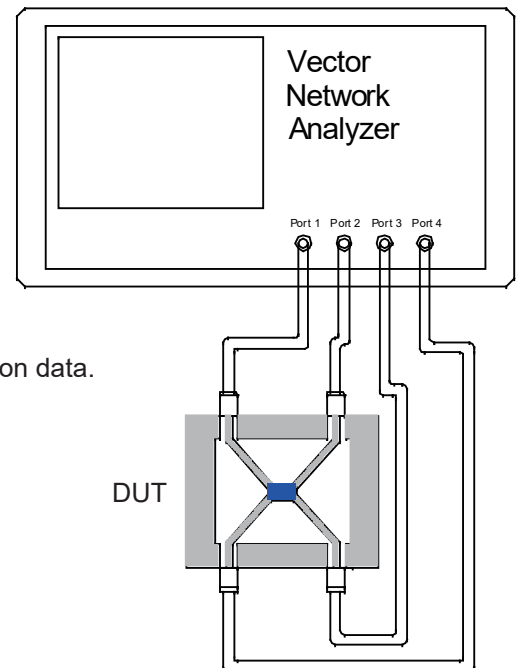

Recommended PCB Layout

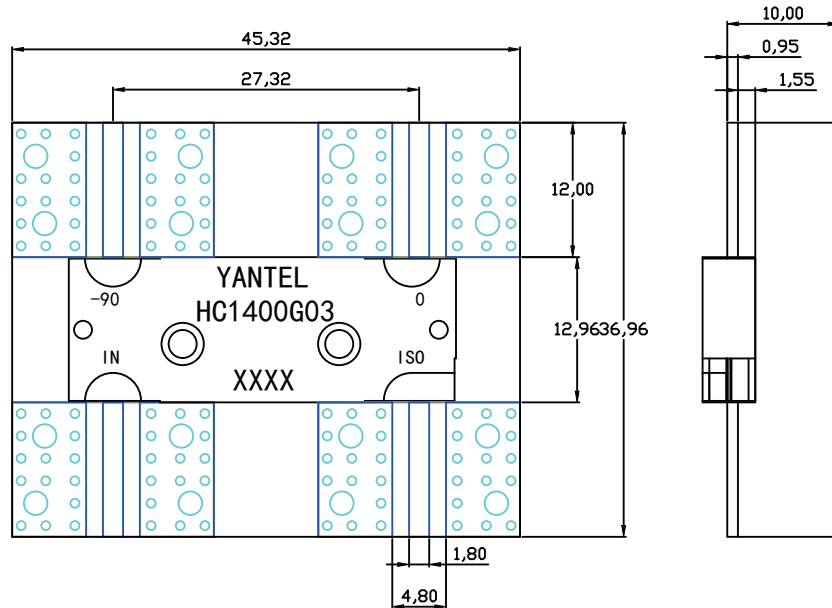
NOTE:

TRACE WIDTH IS SHOWN FOR ROGERS RO4003 WITH DIELECTRIC THICKNESS 32mil;
COPPER: 1 OZ. EACH SIDE. FOR OTHER MATERIALS TRACE WIDTH MAY NEED TO BE MODIFIED.

Reflow Profile

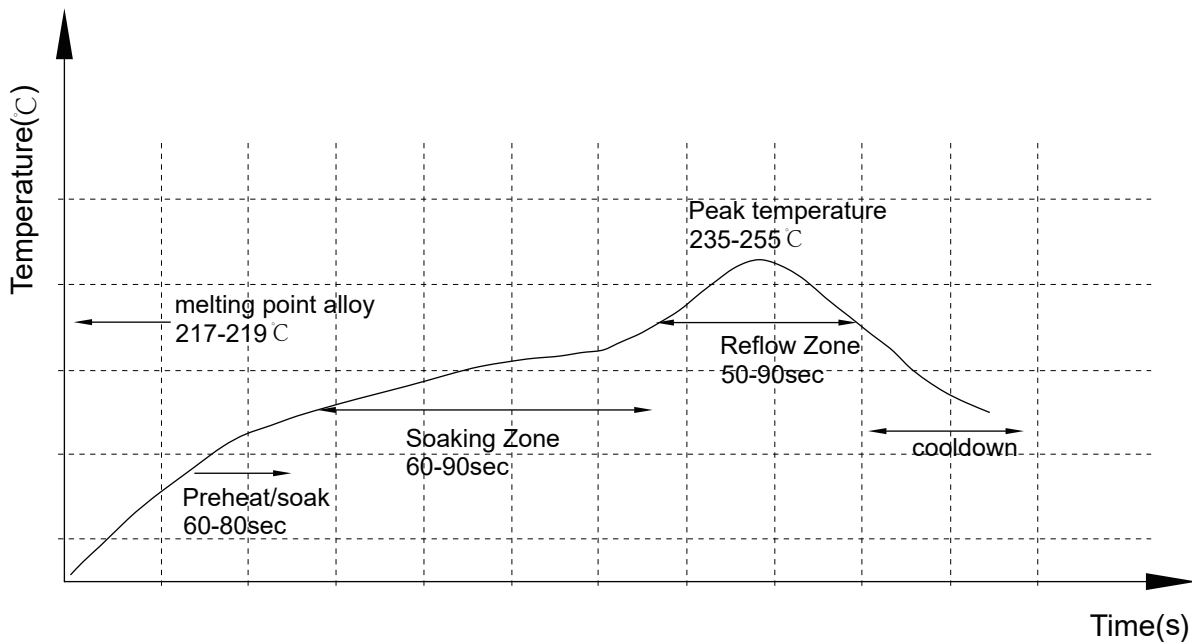

Yantel Corporation

Add: No.308-322, 3F, Building 1, Juchuang Jingu Innovation Park, Wenyuan Road 35, Xili Street, Nanshan, Shenzhen, China
Tel: 86-755-8355-1886 Fax: 86-755-8355-2533

For detailed performance specs & shopping online see Yantel web site : www.yantel-corp.com

Reliability Test Flow

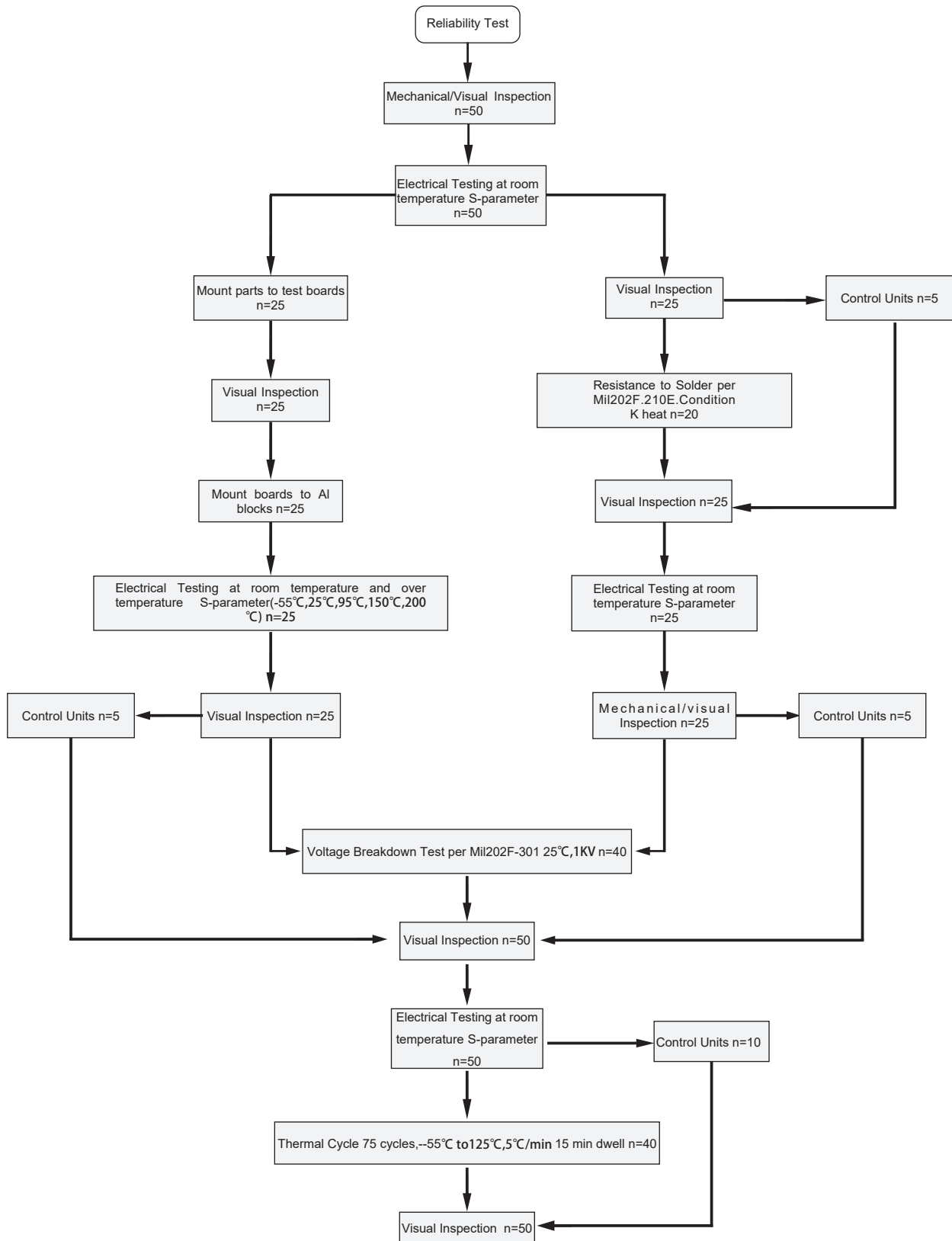

Reliability Test Flow

